



 ANUPEXIM.COM



HYDRAULIC LIFTER

 [+91 8200 907 903](tel:+918200907903)

 INFO@ANUPEXIM.COM

 57 G.I.D.C BHARUCH 392001 GUJ. INDIA

 WWW.ANUPEXIM.COM

HYDRAULIC LIFTER

GAS PUMP - 9 INCH



Finiesh: Silver Finished Cylinder,
Chrome finished piston rod

Material: Mild Steel, Nylon

Specification: Flat characteristic with small force increase,
Different forces for the same dimensions,
Damped fixed speed,
Oil incorporated for cushioning & seal lubrication
Different fixing end-connection

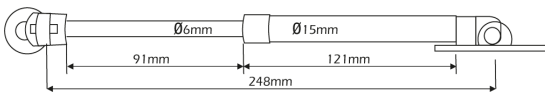

A484901 : 05 Kg / 050 N
A484902 : 10 Kg / 100 N
A484903 : 15 Kg / 150 N
A484904 : 20 Kg / 200 N
A484905 : 25 Kg / 250 N

GAS PUMP - 12 INCH

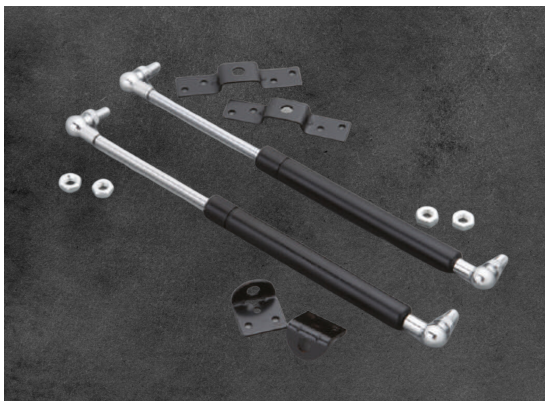

Finiesh: Black Finished Cylinder,
Chrome finished piston rod

Material: Mild Steel

Specification: Specially Design for wooden fittings,
Different forces for the same dimensions,
High Durability, Long Life,
Oil incorporated for cushioning & seal lubrication

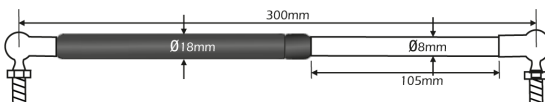

A484906 : 05 Kg / 050 N
A484907 : 10 Kg / 100 N
A484908 : 15 Kg / 150 N
A484909 : 20 Kg / 200 N
A484910 : 25 Kg / 250 N
A484911 : 30 Kg / 300 N
A484912 : 35 Kg / 350 N
A484913 : 45 Kg / 450 N
A484914 : 50 Kg / 500 N

HYDRAULIC LIFTER

GAS PUMP - 15 INCH

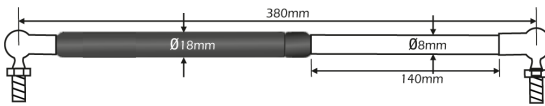
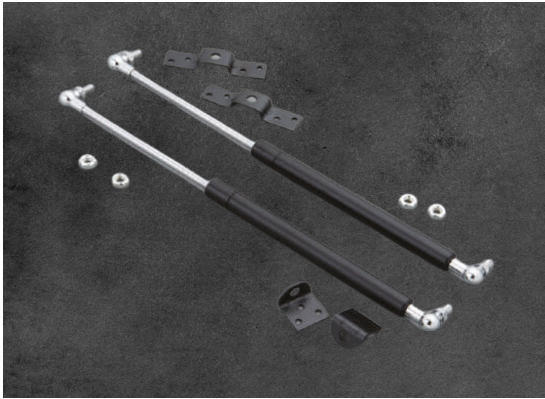

Finiesh: Black Finished Cylinder,
Chrome finished piston rod

Material: Mild Steel

Specification: Specially Design for wooden fittings,
Different forces for the same dimensions,
High Durability, Long Life,
Oil incorporated for cushioning & seal lubrication

- A485001 : 10 Kg / 100 N
- A485002 : 15 Kg / 150 N
- A485003 : 20 Kg / 200 N
- A485004 : 25 Kg / 250 N
- A485005 : 30 Kg / 300 N
- A485006 : 35 Kg / 350 N
- A485007 : 40 Kg / 400 N
- A485008 : 45 Kg / 450 N
- A485009 : 50 Kg / 500 N



GAS PUMP - 18 INCH

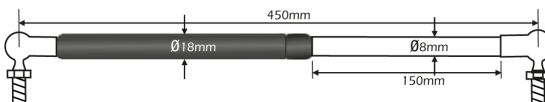
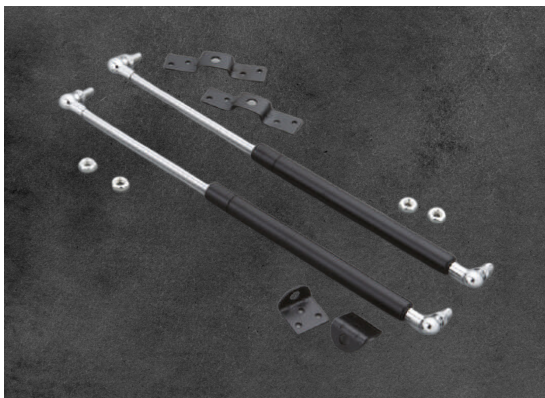

Finiesh: Black Finished Cylinder,
Chrome finished piston rod

Material: Mild Steel

Specification: Specially Design for wooden fittings,
Different forces for the same dimensions,
High Durability, Long Life,
Oil incorporated for cushioning & seal lubrication

- A485010 : 50 Kg / 500 N
- A485011 : 75 Kg / 750 N
- A485012 : 100 Kg / 1000N
- A485013 : 125 Kg / 1250 N
- A485014 : 150 Kg / 1500 N



HYDRAULIC LIFTER

CABINET LIFTER



Finiesh: Plastic Grey Body,
Aluminum Silver Arm

Material: Mild Steel, PVC, Aluminum

Specification: Soft Closing mechanism,
Adjustable Pressure,
Adjustable lift rod support,
Required 1 pcs upto 900mm(W) x 400mm(H),
Required 2 pcs upto 1600mm(W) x 400mm(H)
Load Capacity 4 Kg / 40 N



A485101 : Left Mounting
A485102 : Right Mounting

BI-FOLD SYSTEM

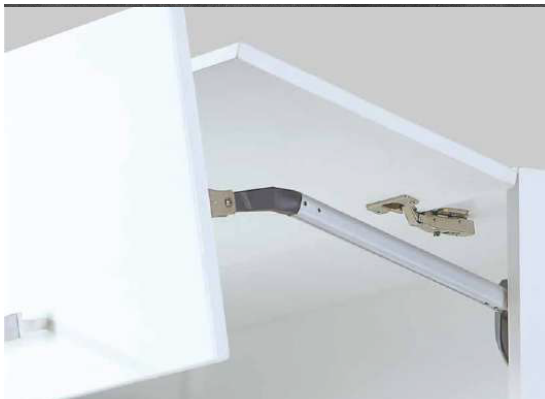

Finiesh: Plastic Grey Body,
Aluminum Silver Arm

Material: Mild Steel, PVC, Aluminum

Specification: Soft Closing,
200mm rod for 450mm to 750mm,
300mm rod for 650mm to 950mm,
Easy installation guide



A485103 : 200 mm Rod - 7 Kg
A485104 : 200 mm Rod - 8 Kg
A485105 : 300 mm Rod - 8 Kg
A485106 : 300 mm Rod - 9 Kg

HYDRAULIC LIFTER

BED HYDRAULIC LIFTER

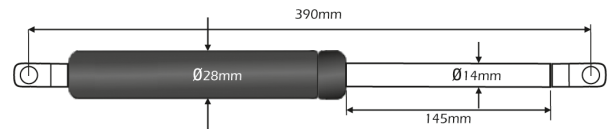
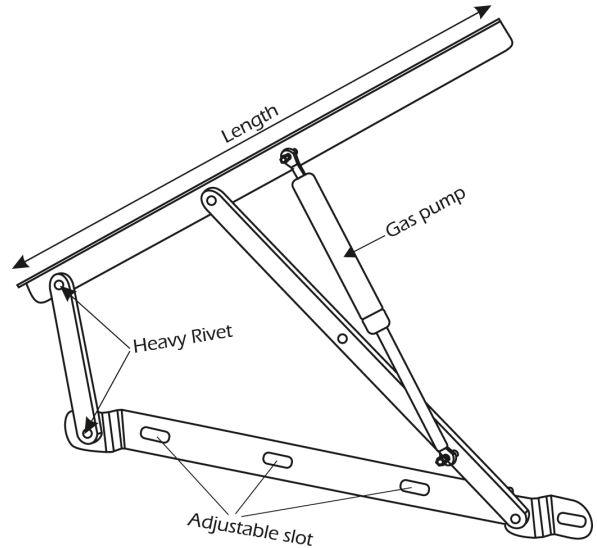

Finish: Sand Black Powder coated Finish Frame,
Black finish Gas Pump

Material: Mild Steel

Specification: 10mm (t) x 30mm (w) two vertical support
5mm x 35mm x 35mm L shaped Angle of Frame,
28mm dia of Gas pump Cylinder,
14mm dia of Gas pump Piston rod,
High Durability and Hardness,
Different load capacity of pump for same Frame,
Long Life, Heavy pneumatic gas pump,
Oil incorporated for cushioning & seal lubrication
Easy to install,

Keep away from thinner and color,
Keep away from heat,

A485201 : 3 Feet Frame Only
A485202 : 4 Feet Frame Only
A485203 : 5 Feet Frame Only
A485204 : 75 Kg / 750 N
A485205 : 100 Kg / 1000 N
A485206 : 125 Kg / 1250 N
A485207 : 150 Kg / 1500 N
A485208 : 175 Kg / 1750 N
A485209 : 200 Kg / 2000 N
A485210 : 250 Kg / 2500 N



HYDRAULIC LIFTER

COFFEE TABLE - EXPANDABLE



Finiesh: Black powder coated Body
 Material: Mild Steel,
 Specification: Soft Close mechanism
 Expandable Table Top,
 Easy to install
 Long Life



A485301 : 450mm

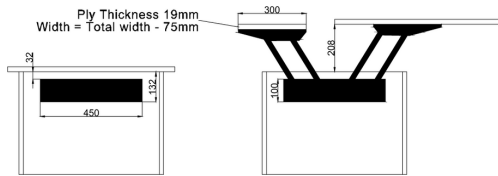

COFFEE TABLE - LIFT UP



Finiesh: Black powder coated Body
 Material: Mild Steel
 Specification: Soft Close mechanism,
 Lifting height 200mm
 Easy to install,
 Long Life



A485302 : 12 inch

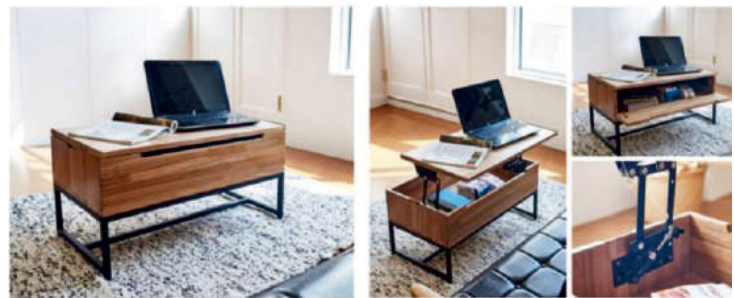
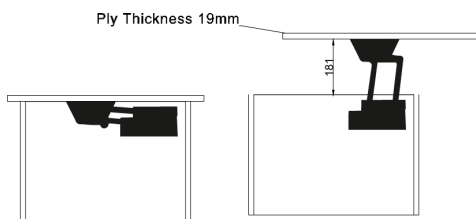

HYDRAULIC LIFTER

PORTABLE DINNING TABLE



Finiesh: Aluminum Silver / Zinc Plated Finish
Material: Aluminum or Mild Steel
Specification: Best product for space Utilization
 Space Saving Mechanism,
 Long Life, Maintenance free,
 Easy to install,
 All in one for Pot Table, Computer Table,
 Dining Table

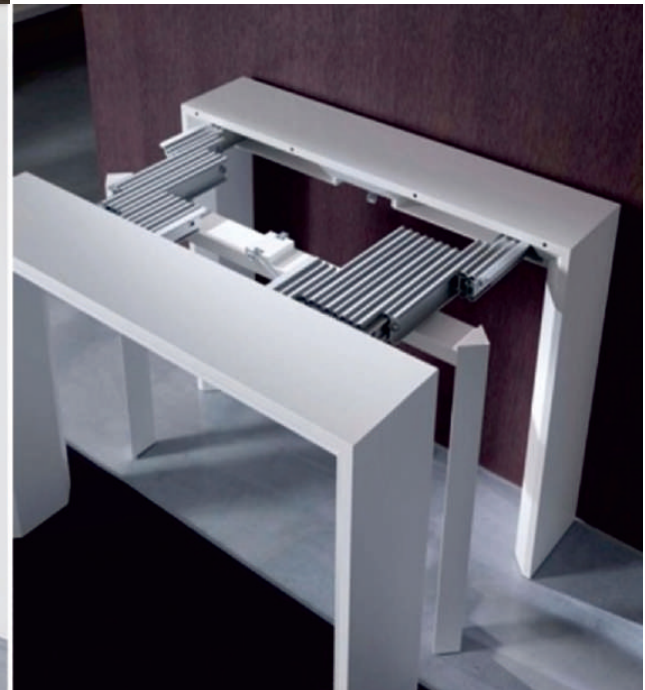

Product code	Load Capacity	Closing Length	Expandable Length	Material	Master pack
A485401	60 Kg	450mm	1800mm	Mild Steel	1 Set
A485402	100 Kg	450mm	1800mm	Aluminum	1 Set

HYDRAULIC LIFTER

FOLDING DINING TABLE



Finiesh: Grey Powder Coated
 Material: Mild Steel and Aluminum
 Specification: Wall mount type
 Bearing roller system,
 Easy to install,

- A485501 : 24 inch
- A485502 : 30 inch
- A485503 : 36 inch
- A485504 : 48 inch
- A485505 : 60 inch



FOLDING BRACKET



Finiesh: White / Dark Grey Powder Coated
 Material: Mild Steel
 Specification: Wall mount type
 1.2mm thickness of plate,
 Easy to install

- A485506 : 12 inch - 300 mm
- A485507 : 16 inch - 400 mm
- A485508 : 20 inch - 500 mm
- A485509 : 24 inch - 600 mm



MICRO-OVEN STAND



Finiesh: Black Powder Coated
 Material: Mild Steel
 Specification: High Load Capacity
 Easy to install, high durability

- A485601 : 300mm-450mm



Thank You



[+91 8200 907 903](tel:+918200907903)



INFO@ANUPEXIM.COM



[57 G.I.D.C BHARUCH 392001 GUJ. INDIA](#)



WWW.ANUPEXIM.COM